

ASSEMBLY INSTRUCTION

ITEM NO.:HM8053-2

Parts list:

A

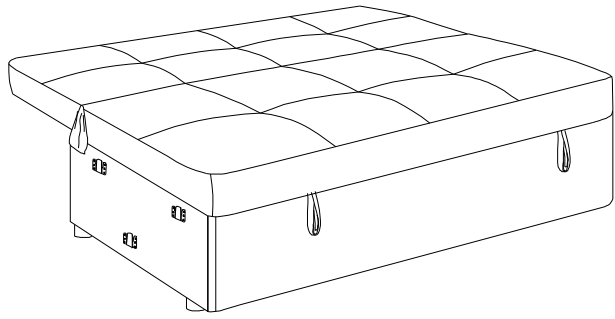

1PC

B

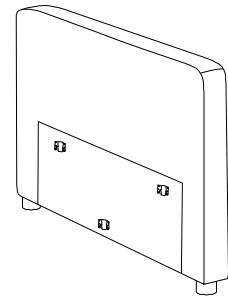

2PCS

Step 1:

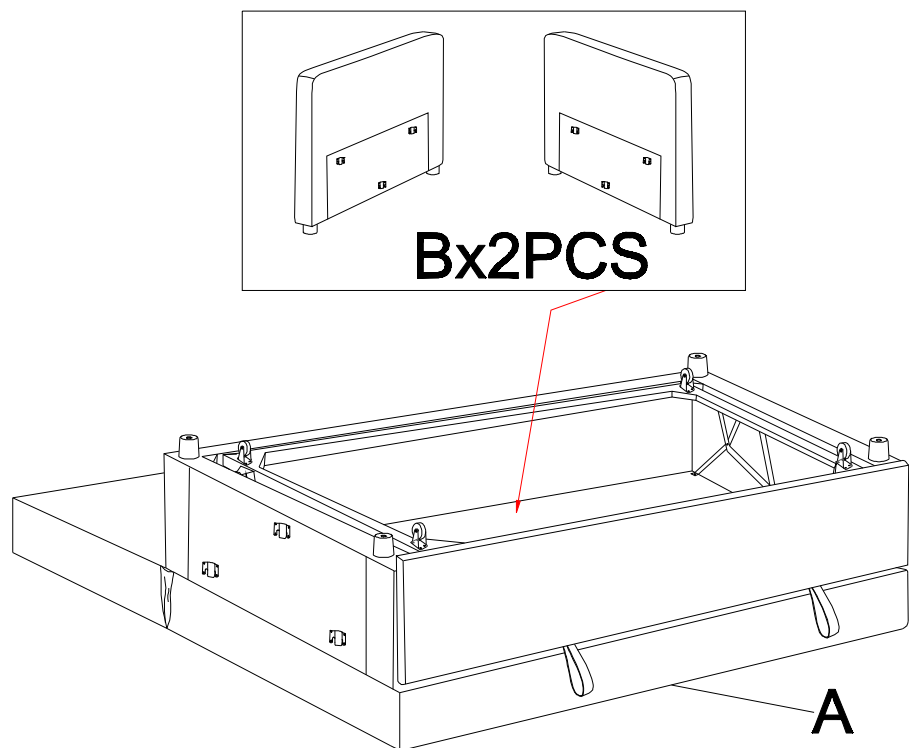

Step 2:

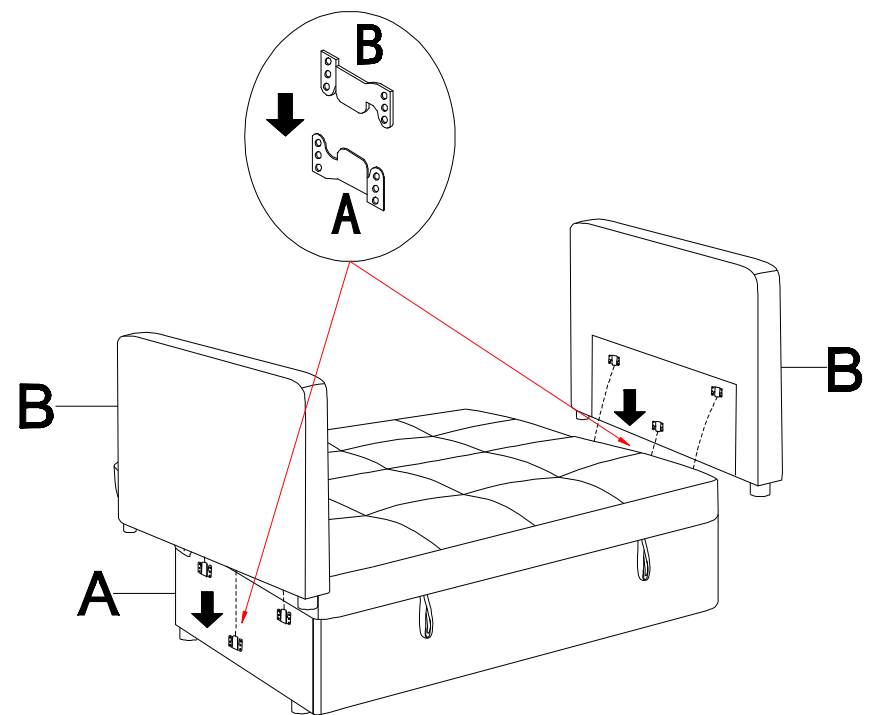

Step 3:

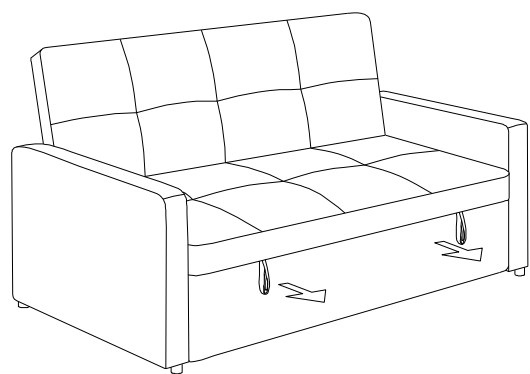

Step 4:

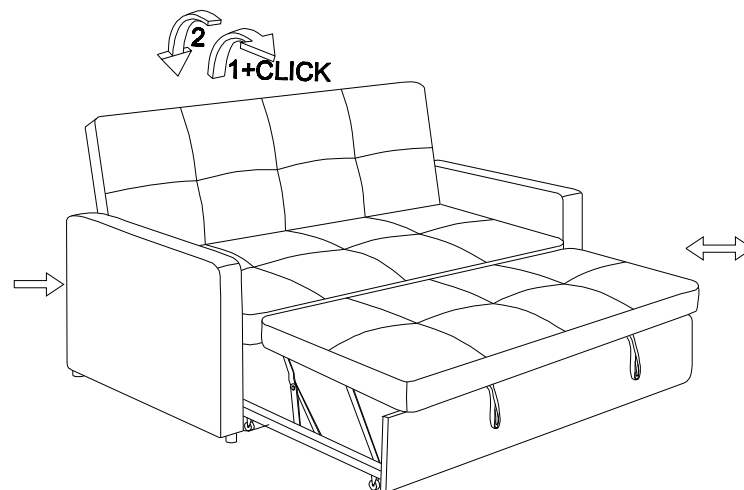

Step 5:

