





P. No	שם החלק	כמות	איור
1	משטח השולחן	1	
2	רגל	4	
3	תחתית סיליקון	4	
4	בורג	4	
5	בורג (3,5mmx18mm)	16	

1



2

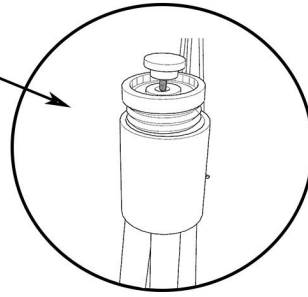
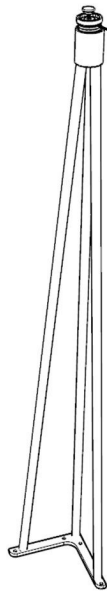
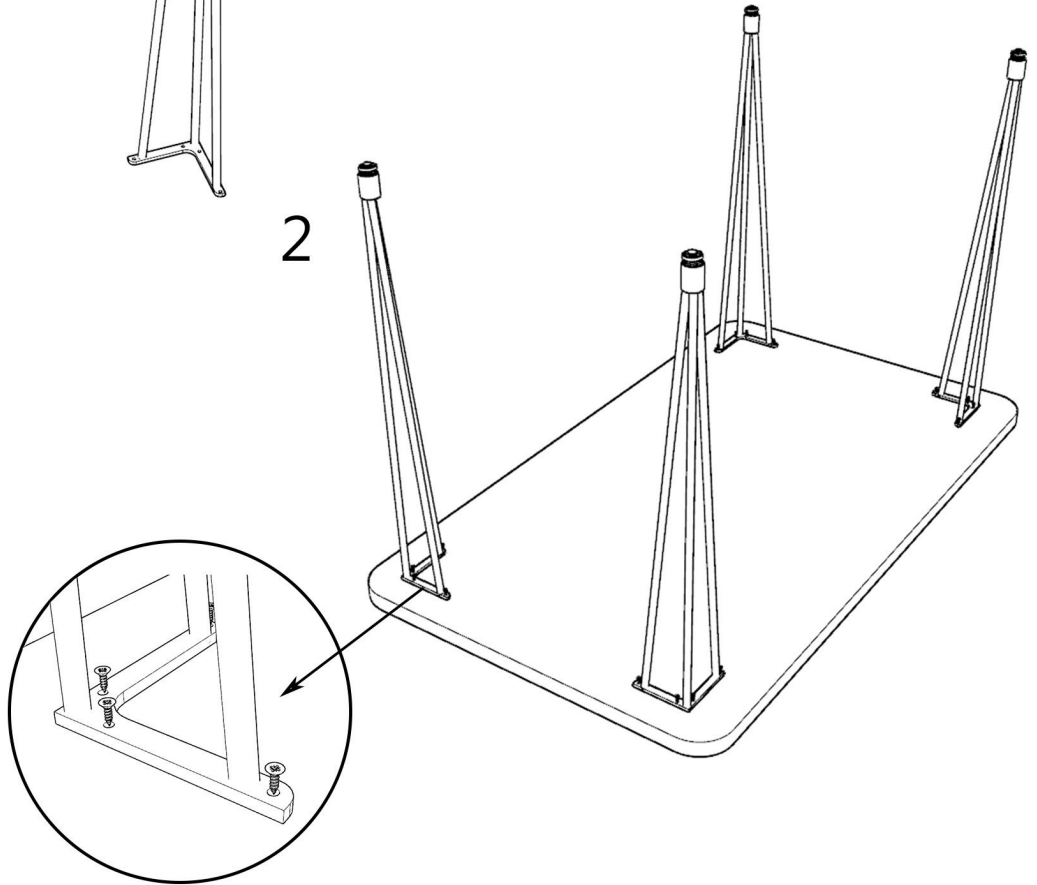

3

